

F2X14 Series IP MODEM User Manual	Document Version	Page
	V2.0.0	
	Product Name: F2X14	Total:40

F2X14 Series IP MODEM User Manual

The user manual is suitable for the following model:

Model	Product Type
F2114	GPRS IP MODEM
F2214	CDMA IP MODEM
F2414	WCDMA IP MODEM
F2614	EVDO IP MODEM



Xiamen Four-Faith Communication Technology Co., Ltd.

Add: J1-J3, 3rd Floor, No.44, Guanri Road, Software Park, Xiamen, China

Postal Code:361008

Tel: +86 -592-6300320

Fax:+86-592-5912735

<http://en.four-faith.com>



Files Revised Record

Date	Version	Remark	Author
2011-3-3	V1.0.0	Initial version	
2015-5-28	V1.0.1	Add the following parameters configuration instructions 1.Management platform parameters 2.Disconnect after re-enter trigger mode 3.Network offline free time 4.Hex heartbeat package registered package 5.The low level link heartbeat mechanism 6.SMS configuration parameters 7.The MODBUS parameters configuration 8.Port Interface Settings 9.SMS Settings	WWJ
2016-10-24	V2.0.0	Parameter configuration to do the following changes 1.add "SMS receive to the serial port" 2.remove "timing switch machine" 3.Add "RTC time settings" 4.Add"Language setting" 5.Add "PPP Authentication Mode" Modify text version name and version number	WWJ

Copyright Notice

All contents in the files are protected by copyright law, and all copyrights are reserved by Xiamen Four-Faith Communication Technology Co., Ltd. Without written permission, all commercial use of the files from Four-Faith are forbidden, such as copy, distribute, reproduce the files, etc., but non-commercial purpose, downloaded or printed by individual (all files shall be not revised, and the copyright and other proprietorship notice shall be reserved) are welcome.

Trademark Notice

Four-Faith、四信、、、 are all registered trademarks of Xiamen Four-Faith Communication Technology Co., Ltd., illegal use of the name of Four-Faith, trademarks and other marks of Four-Faith is forbidden, unless written permission is authorized in advance.



Note: There may be different components and interfaces in different model, please in kind prevail.

Contents

Chapter 1 Brief Introduction of Product.....	6
1.1 General.....	6
1.2 Features and Benefits.....	6
1.3 Working Principle.....	7
1.4 Specifications.....	8
Chapter 2 Installation Introduction.....	11
2.1 General.....	11
2.2 Encasement List.....	11
2.3 Installation and Cable Connection.....	11
2.4 Power.....	14
2.5 Indicator Lights Introduction.....	14
Chapter 3 Configuration.....	15
3.1 Configuration Connection.....	15
3.2 Configuration Introduction.....	15
3.3 Run the configure Tool: IP Modem Configure.exe.....	16
3.4 Re-power IP MODEM.....	17
3.5 Configuration.....	17
3.5.1 Data Service Center Settings.....	17
3.5.2 IP MODEM Settings.....	21
3.5.3 Other Settings.....	28
3.5.4 ModBus Setting.....	32
3.5.5 Port Interface Settings.....	33
3.5.6 SMS Setting.....	34
3.6 Functions.....	35
3.7 Work State Switch.....	37
Appendix.....	38

Chapter 1 Brief Introduction of Product

1.1 General

F2X14 series IP MODEM is a kind of cellular terminal device that provides data transfer by public cellular network.

It adopts high-powered industrial 32 bits CPU and embedded real time operating system. It supports RS232 and RS485 (or RS422) port that can conveniently and transparently connect one device to a cellular network, allowing you to connect to your existing serial devices with only basic configuration. It has low power consumption states. It has compatible digital I/O channel, ADC, input pulse counter and pulse wave output function.

It has been widely used on M2M fields, such as intelligent transportation, smart grid, industrial automation, telemetry, finance, POS, water supply, environment protection, post, weather, and so on.

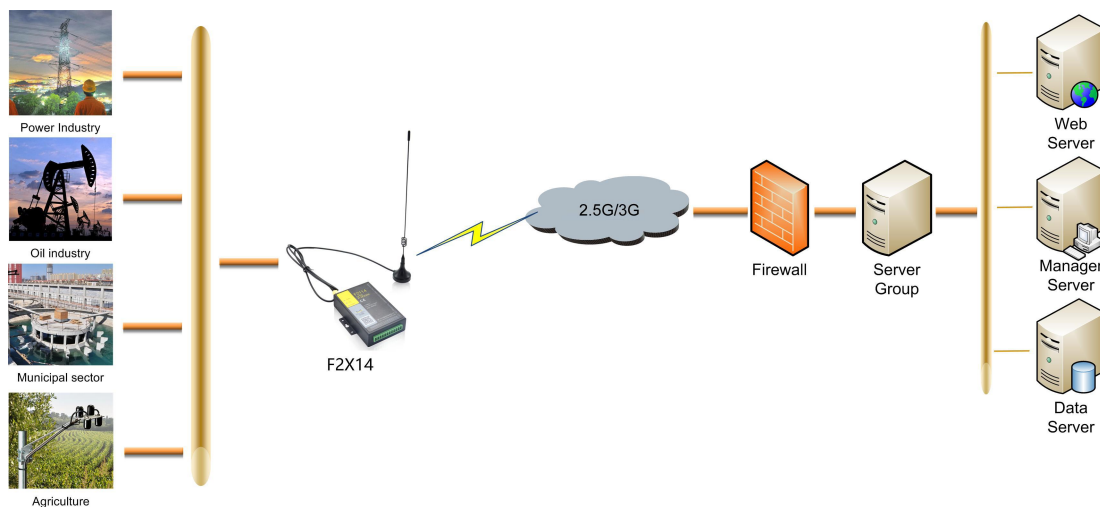

1.2 Features and Benefits

Design for Industrial Application

- ◆ High-powered industrial cellular module
- ◆ High-powered industrial 32 bits CPU
- ◆ Low power consumption design, support multi-sleep and trigger modes to reduce the power dissipation farthest
- ◆ Embedded Real Time Clock(RTC) circuit
- ◆ Housing: iron, providing IP30 protection

[Xiamen Four-Faith Communication Technology Co.,Ltd.](http://www.four-faith.com)

Add: J1-J3, 3rdFloor, No.44, Guanri Road, Software Park, Xiamen .361008.China

http://www.four-faith.com Tel: +86-592-6300320 Fax: +86-592-5912735

- ◆ Power range: DC 5~36V

Stability and Reliability

- ◆ Support hardware and software WDT
- ◆ Support auto recovery mechanism, including online detect, auto redial when offline to make it always online
- ◆ RS232/RS485/RS422 ports:15KV ESD protection
- ◆ SIM/UIM port: 15KV ESD protection
- ◆ Power port: reverse-voltage and overvoltage protection
- ◆ Antenna port: lightning protection(optional)

Standard and Convenience

- ◆ Adopt terminal block interface, convenient for industrial application
- ◆ Support standard RS232/RS485 ports that can connect to serial devices directly
- ◆ TTL logic level RS232 interface can be customized
- ◆ Support intellectual mode, enter into communication state automatically when powered
- ◆ Provide management software for remote management
- ◆ Support several work modes
- ◆ Convenient configuration and maintenance interface

High-performance

- ◆ Support TCP server and support multi TCP client connection(optional)
- ◆ Support double data centers, one main and another backup
- ◆ Supply 5 I/O channels, compatible 2 pulse wave output channels, 2 analog inputs and one pulse input counters.
- ◆ Support multi data centers and it can support 5 data centers at the same time
- ◆ Support multi online trigger ways, including SMS, ring and data. Support link disconnection when timeout
- ◆ Support dynamic domain name(DDNS) and IP access to data center
- ◆ Design with standard TCP/IP protocol stack
- ◆ Support APN/VPDN

1.3 Working Principle

The principle chart of the Router is as following:

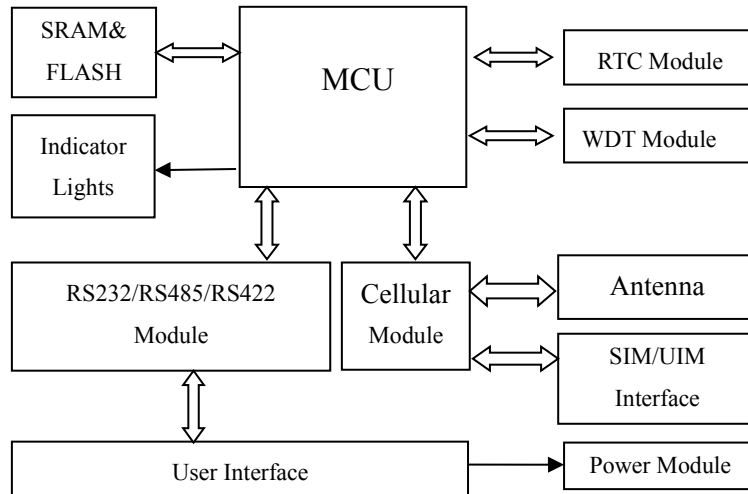

1.4 Specifications

Cellular Specification

ITEM	CONTENT
F2114 GPRS IP MODEM	
Standard and Band	EGSM 900/GSM 1800MHz, GSM 850/900/1800/1900MHz(optional) Compliant to GSM phase 2/2+ GPRS class 10, class 12(optional)
Bandwidth	85.6Kbps
TX power	GSM850/900:<33dBm GSM1800/1900:<30dBm
RX sensitivity	<-107dBm
F2214 CDMA IP MODEM	
Standard and Band	CDMA2000 1xRTT 800MHz, 450MHz(optional)
Bandwidth	153.6Kbps
TX power	<30dBm
RX sensitivity	<-104dBm
F2414 WCDMA IP MODEM	
Standard and Band	UMTS/WCDMA/HSDPA/HSUPA/HSPA+ 850/1900/2100MHz, 850/900/1900/2100MHz(optional)

	GSM 850/900/1800/1900MHz GPRS/EDGE CLASS 12
Bandwidth	DC-HSPA+: Download speed 42Mbps, Upload speed 5.76Mbps HSPA+: Download speed 21Mbps, Upload speed 5.76Mbps HSDPA: Download speed 7.2Mbps, HSUPA: Upload speed 5.76Mbps UMTS: 384Kbps
TX power	<24dBm
RX sensitivity	<-109dBm
F2614 EVDO IP MODEM	
Standard and Band	CDMA2000 1X EVDO Rev A 800MHz, 800/1900MHz(optional), 450MHz(optional) CDMA2000 1X EVDO Rev B 800/1900MHz(optional) CDMA2000 1X RTT, IS-95 A/B
Bandwidth	EVDO Rev. A: Download speed 3.1Mbps, Upload speed 1.8Mbps EVDO Rev. B: Download speed 14.7Mbps, Upload speed 5.4Mbps (optional)
TX power	<23dBm
RX sensitivity	<-104dBm

Hardware System

Item	Content
CPU	Industrial 32 bits CPU
FLASH	512KB(Extendable)
SRAM	256KB(Extendable)

Interface Type

Item	Content
Serial	1 RS232 port and 1 RS485(orRS422) port, 15KV ESD protection Data bits: 5, 6, 7, 8 Stop bits: 1, 1.5, 2 Parity: none, even, odd, space, mark Baud rate: 110~230400 bps
Indicator	"Power", "ACT", "Online"
Antenna	Standard SMA female interface, 50 ohm, lightning protection(optional)
SIM/UIM	Standard user card interface, support 1.8V/3V SIM/UIM card, 15KV ESD protection
Power	Terminal block interface, reverse-voltage and overvoltage protection

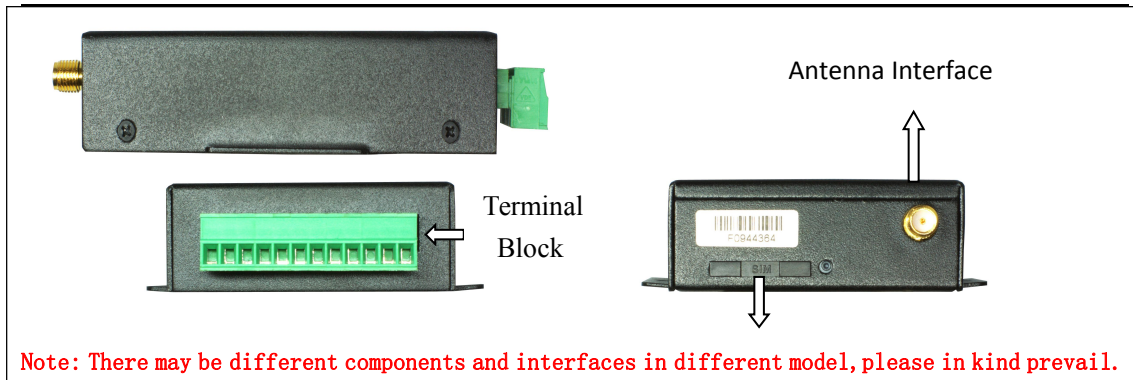

Power Input

Item	Content
Standard Power	DC 12V/0.5A
Power Range	DC 5~36V

Consumption

Working condition	Consumption
Standby	3G:16~29mA@12VDC 2G:12~15mA@12VDC
Communication	3G:70~200mA@12VDC 2G:30~35mA@12VDC

Physical Characteristics

Item	Content
Housing	Iron, providing IP30 protection
Dimensions	91x58.5x22 mm
Weight	210g

Environmental Limits

Item	Content
Operating Temperature	-35~+75°C(-31~+167°F)
Storage Temperature	-40~+85°C(-40~+185°F)
Operating Humidity	95% (Non-condensing)

Chapter 2 Installation Introduction

2.1 General

The IP MODEM must be installed correctly to make it work properly.

Warning: Forbid to install the IP MODEM when powered!

2.2 Encasement List

Name	Quantity	Remark
IP MODEM host	1	
Antenna	1	
Power adapter	1	
RS232 data cable	1	optional
RS485 data cable	1	optional
Manual CD	1	
Certification card	1	
Maintenance card	1	

2.3 Installation and Cable Connection

Dimension: (unit: mm)

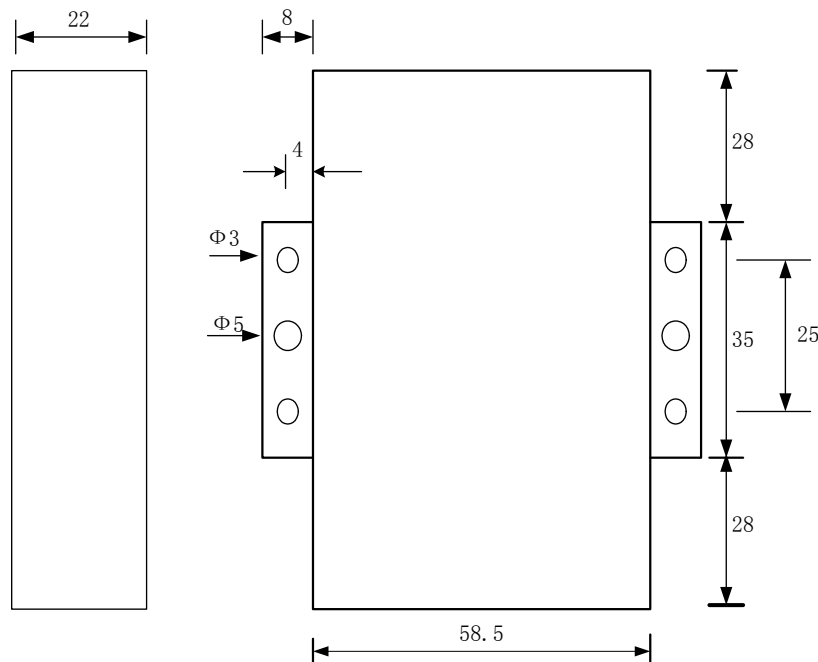

Installation of SIM/UIM card:

Firstly power off the IP MODEM, and press the out button of the SIM/UIM card outlet with a needle object. Then the SIM/UIM card sheath will flick out at once. Put SIM/UIM card into the card sheath (Pay attention to put the side which has metal point outside), and insert card sheath back to the SIM/UIM card outlet.

Warning: Forbid to install SIM/UIM card when powered!

Installation of antenna:

Screw the SMA male pin of the antenna to the female SMA outlet of the IP MODEM tightly. Warning: The antenna must be screwed tightly, or the signal quality of antenna will be influenced!

User Interface Signal Definition

Pin Number	Signal Name	Default Function	Extensible Function
1	PWR	Power input anode	N/A
2	GND	Power Ground	N/A
3	GND	Power Ground	N/A
4	RX	RS232 RX	N/A
5	TX	RS232 TX	N/A
6	A	RS485 anode	Reserved compatible DTR
7	B	RS485 cathode	Reserved compatible DSR
8	IO1	GPIO	Reserved compatible RTS and RS232 RX (TTL logic level)
9	IO2	GPIO	Reserved compatible CTS and

			RS232 TX (TTL logic level)
10	IO3	GPIO	Reserved compatible DCD
11	IO4	GPIO	Reserved compatible RI,ADC, and pulse output
12	IO5	GPIO	Reserved compatible pulse wave input counter, ADC, and pulse output



Installation of cable:

F2X14 adopts industrial terminal block interface. The recommendatory cable is 28-16AWG. The detail description of standard layout adapter and communication cables as is following:

Adapter (Rating Output 12VDC/0.5A) :

Cable Color	Power Output Polarity
Black & White Alternate	Anode
Black	Cathode

RS232 Cable:

Cable Color	Corresponding DB9-M Pin Number
Brown	Pin 2
Blue	Pin 3
Black	Pin 5

RS485 Cable:

Cable Color	Signal definition
Red	RS485(A)
Black	RS485(B)

Power adapter and communication cable connection chart as following:

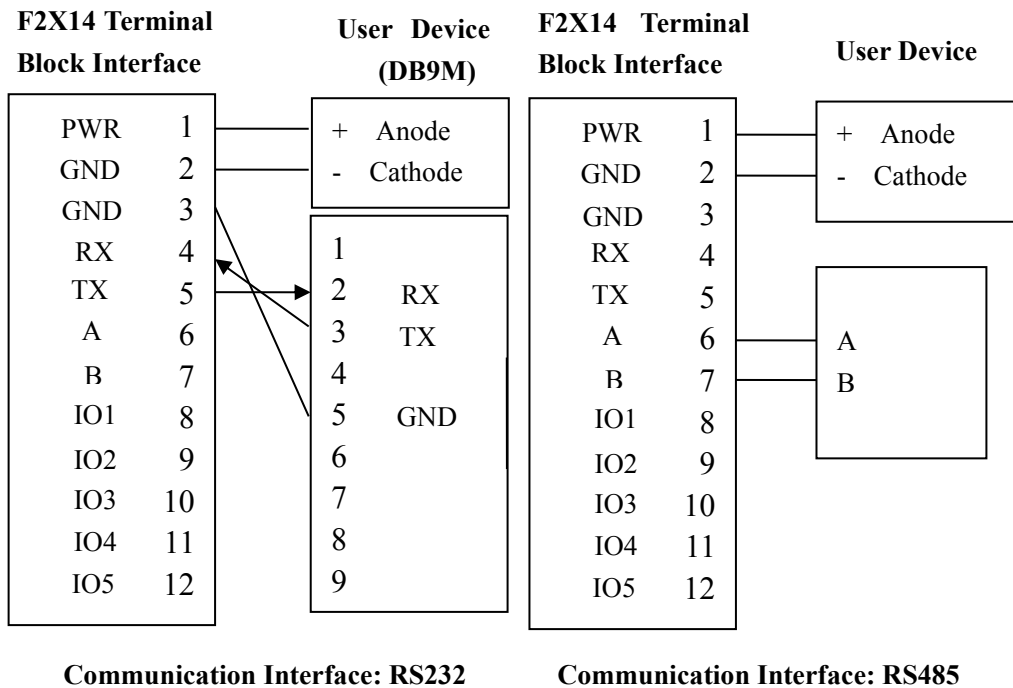

2.4 Power

The power range of the IP MODEM is DC 5~36V.

Warning: When we use other power, we should make sure that the power can supply power above 4W.

We recommend user to use the standard DC 12V/0.5A power.

2.5 Indicator Lights Introduction

The IP MODEM provides three indicator lights: “Power”, “ACT”, “Online”.

Indicator Light	State	Introduction
Power	ON	IP MODEM is powered on
	OFF	IP MODEM is powered off
ACT	BLINK	Data is communicating
	OFF	No data
Online	ON	IP MODEM has logged on network
	OFF	IP MODEM hasn't logged on network

Chapter 3 Configuration

3.1 Configuration Connection

Before configuration, it's necessary to connect the IP MODEM with the configure PC by the shipped RS232 or RS232-485 conversion cable as following.

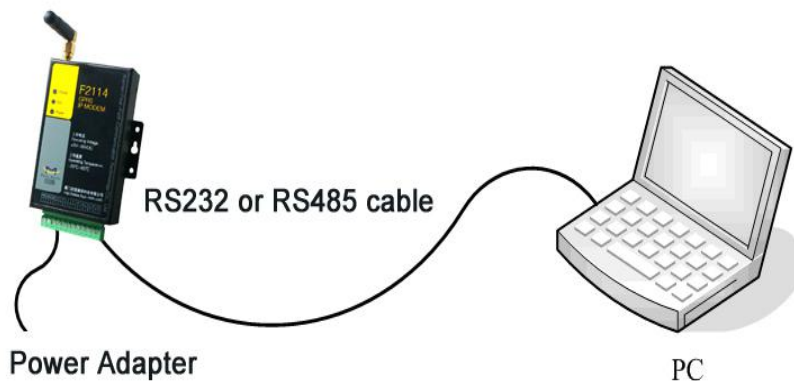

3.2 Configuration Introduction

There are two ways to configure the IP MODEM:

Configuration software tool: All the settings are configured through the shipped software tool. It's necessary to have one PC to run this tool.

Extended AT command: All the settings are configured through AT command, so any device with serial port can configure it. Before configuration with extended AT command, you should make IP MODEM enter configure state. The steps how to make IP MODEM enter configure state, please refer to appendix.

The following describes how to configure IP MODEM with the configure software tool and the corresponding AT command of each configuration item.

3.3 Run the configure Tool: IP Modem Configure.exe

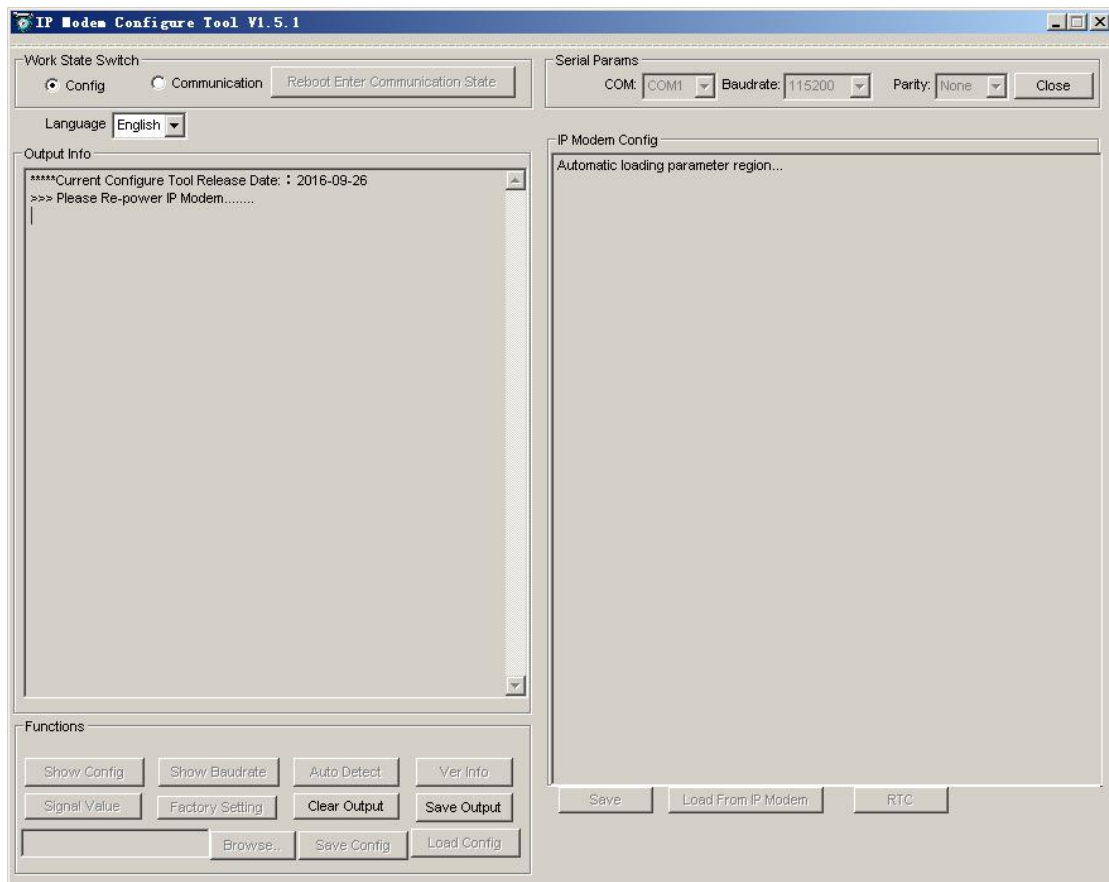

The “Serial Parameters” column shows the current serial port settings. To configure IP MODEM, please choose the correct serial port which connects to IP MODEM, and the baud-rate is 115200 with no parity, then open the serial port. If the button text is “Close”, it shows the serial port now has been opened. If the text is “Open”, you should open the port first. When the port opened, the “Output Info” column will display

“Port(COM1) Has Opened, Please Re-Power the IP MODEM,
Waiting IP MODEM Enter Configure State...”

3.4 Re-power IP MODEM

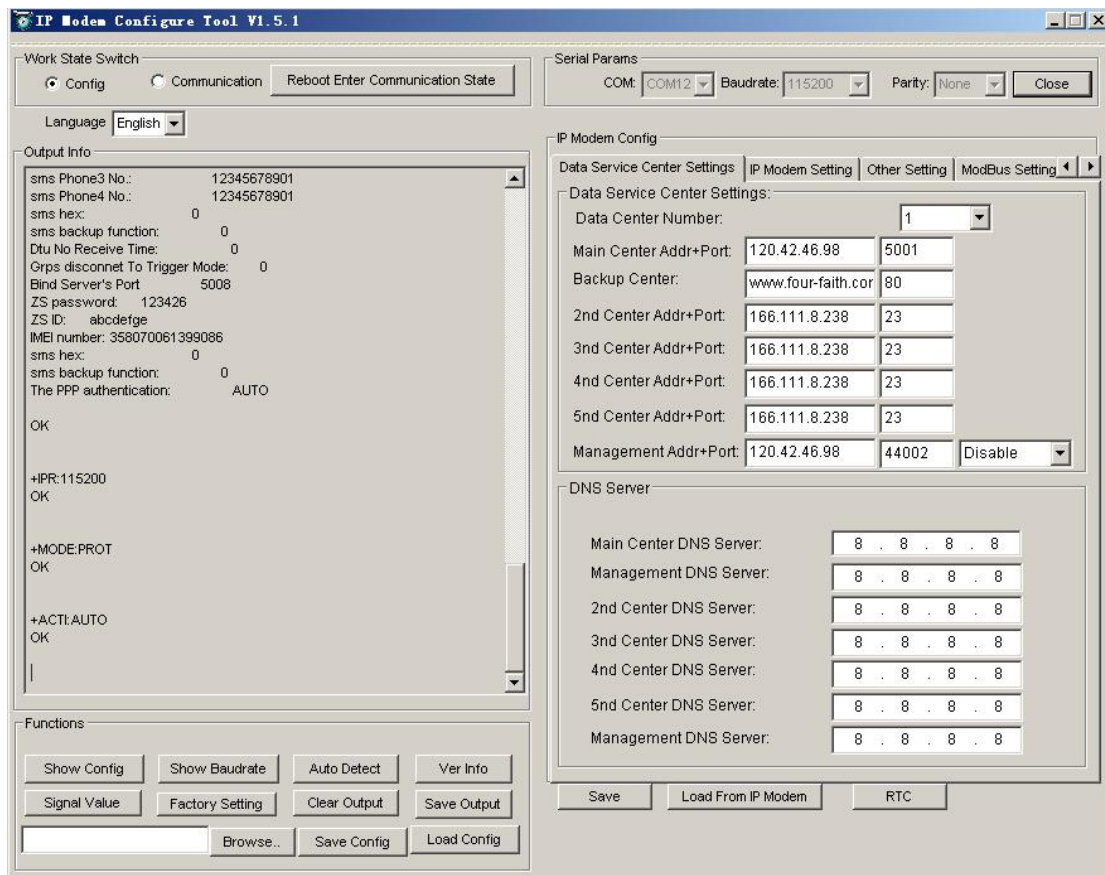

After Re-power IP MODEM, The configure tool will make it enter configure state. At the same time, the software will load current settings from IP MODEM and displays on the right configure columns. It's now ready to configure.

3.5 Configuration

3.5.1 Data Service Center Settings

Settings on this page are the parameters related to Data Service Center (DSC).

◆Data Center Number

IP MODEM support two Data Service Center methods to transmit data.

Main and Backup: IP MODEM always tries to connect with the Main DSC. If fails to connect with Main DSC, it will connect with Backup DSC at once

Note: If no Backup DSC exists, please configure the Backup DSC same as Main DSC.

[Xiamen Four-Faith Communication Technology Co.,Ltd.](http://www.four-faith.com)

Add: J1-J3, 3rdFloor, No.44, Guanri Road, Software Park, Xiamen .361008.China
 http://www.four-faith.com Tel: +86-592-6300320 Fax: +86-592-5912735

Multi Data Service Center: IP MODEM can connect with at most five DSC at the same time. All the multi DSC can receive the same application data .

Data Center Number:

If the Data Center Number is 0, there is no DSC working.

If the Data Center Number is 1, IP MODEM work in Main and Backup DSC method.

When “Data Center Number” is greater than 1, IP MODEM works in Multi Data Service Center method

GPS data transmission DSC is self-governed. Setting details please reference the section 3.5.5.

AT command:

AT+SVRCNT=x

x: Data Service Center number

Note: every AT command is terminated with a enter character.

◆Main Center Addr+Port:

IP Address and Port of the Main DSC, It's better to set the port greater than 1024.

Main Center Addr+Port:

AT command of the Main DSC IP address or domain name:

AT+IPAD=xxx

xxx: The IP address or domain name.

AT command of the Main DSC port:

AT+PORT=xxx

xxx: The port value

◆Backup Center Addr+Port:

IP address and port of the Backup DSC

Backup Center Addr+Port:

AT command of the Backup DSC IP address or domain

AT+IPSEC=xxx

xxx: The IP address or domain name

AT command of the Backup DSC port

AT+PTSEC=xxx

xxx: The port value

◆Multi DSC Configuration

2nd Center Addr+Port:	166.111.8.238	23
3rd Center Addr+Port:	166.111.8.238	23
4th Center Addr+Port:	166.111.8.238	23
5th Center Addr+Port:	166.111.8.238	23

When “Data Center Number” is greater than 1, this setting is valid. For example, setting the “Data Center Number” as 3, Main Center, 2nd Center, 3rd Center work as these three DSC

AT Command of the 2~5 DSC IP address or domain name

AT+IPADn=xxx

n is 1~4 correspond to center 2~5

xxx: The IP address or domain name

AT Command of the 2~5 DSC port

AT+PORTn=xxx

n is 1~4 correspond to port of center 2~5

xxx: The port value

Example:

Set IP address of center 3 as 166.111.8.238, and port 5001, the AT command is as following:

AT+IPAD2=166.111.8.238

AT+PORT2=5001

◆Manage Addr+Port

Manage Addr+Port:	120.42.46.98	44002	Disable
DNS Server			Disable Enable

IP MODEM management platform is mainly used to remote configuration, remote upgrade equipment, as well as the equipment location tracking and positioning.

The expansion of the IP MODEM management platform of IP or domain name AT commands are:

AT+DTUMANAIP=xxx

XXX as the center of the domain name or IP address

the expansion of the IP MODEM management platform port AT commands are:

AT+DTUMANAPORT=xxx
XXX is a center of port number

Not all of the terminals are need management platform, so can choose to enable or disable IP MODEM management platform. After disable IP MODEM will not go to the address of the connection Settings.

The expansion of the IP MODEM management platform to enable or disable the AT command are:

AT+CONNTOMANA=x
When x is 0 disables equipment management platform;
When x is 1 enabled equipment management platform;

◆ Main and Backup Center DNS Server

Main Center DNS Server:	202.101.103.55
Backup Center DNS Server:	211.138.151.161

When the DSC Internet access uses domain name, It's necessary to set DNS server resolving the DSC domain name. When the Data Center Number is 1, Main and Backup Center DNS Server is used to resolve the Main center and Backup center correspondingly.

AT command of Main Center DNS server:
AT+DNSSVR=aaa.bbb.ccc.ddd
aaa.bbb.ccc.ddd: The DNS server IP address(must be IP address) .

AT command of Backup Center DNS server:

AT+DNSSV2=aaa.bbb.ccc.ddd
aaa.bbb.ccc.ddd: the DNS server IP address

◆ Center 2~5 DNS Server

When the IP MODEM work in Multi Data Service Center method and the centers use domain name, 2~5 DNS server is used to resolve center 2~5 correspondingly.

AT command of 2~5 DNS Server
AT+DNSSVRn=aaa.bbb.ccc.ddd

n is 1~4 correspond to center 2~5 DNS server.

aaa.bbb.ccc.ddd is the DNS server IP address

3.5.2 IP MODEM Settings

◆ IP MODEM WorkkMode



According to different application requirements, there are several protocol workmode to choose.

PROT : Heartbeat packet with TCP protocol, Data transmission with TCP protocol, heartbeat packet and application data transmission are in the same TCP connection.

TRNS: IP MODEM work as a common GPRS MODEM, It can be used in SMS, CSD, Dial-up applications.

TTRN: Heartbeat packet with UDP protocol, Data transmission with TCP protocol

TLNT: IP MODEM work as a telnet client

LONG: Heartbeat packet with UDP protocol, Data transmission with TCP protocol, It can transmit at most 8192 bytes data one time through extra application protocol.

LNGT: Heartbeat with UDP protocol, Data transmission with TCP protocol, It can transmit at most 8192 bytes data one time through extra application protocol.

TUDP : Heartbeat with UDP protocol, Data transmission with UDP protocol, Heartbeat packet and application data are in the same UDP connection.

TCST: User can set custom register and heartbeat string, Data transmission with TCP protocol.

AT command:

AT+MODE=xxxx

xxxx: one of the above workmode

◆ Trigger Type

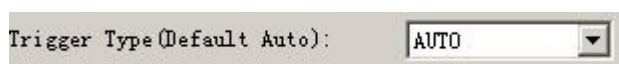

Normally, IP MODEM always keeps online and always be ready for data transmission. But in some circumstances, it's important to reduce wireless data flow. To realize this function, the software can makes IP MODEM into sleep state in idle time. When there is

[Xiamen Four-Faith Communication Technology Co.,Ltd.](http://www.four-faith.com)

Page 21 of 40

Add: J1-J3, 3rdFloor, No.44, Guanri Road, Software Park, Xiamen .361008.China

http://www.four-faith.com Tel: +86-592-6300320 Fax: +86-592-5912735

application data to transmit, IP MODEM can be triggered online ready for data transmission. There are total five methods to make IP MODEM online:

AUTO: IP MODEM always keeps online

SMSD: send a special short message to make IP MODEM online

CTRL: make IP MODEM online through a phone call to IP MODEM

DATA: send special serial data to make IP MODEM online

MIXD: the combination of SMSD, CTRL, DATA. IP MODEM will be online when meet one of these three trigger methods.

AT Command:

AT+ACTI=xxxx

xxxx: one of the above trigger methods

◆ Disconnect To Trigger Mode

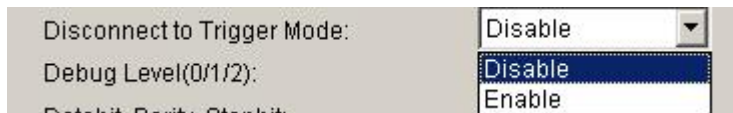

The only effective under the trigger mode except of AUTO. When IP MODEM connection is disconnected with all center will re-enter after trigger mode.

AT Command of the After disconnection re-enter trigger mode:

AT+ISTRIGMODE=x

When x is 0 not enabled to re-enter the trigger mode;

When x is 1 enabled to re-enter the trigger mode;

◆ Debug Level



Debug information is used to debug software when there is software problem.

0 --- no debug information output

1 --- simple prompt information output

2 --- detail debug information output

AT Command:

AT+DEBUG=x

x : the debug level value

Note: Only there is some problem to the IP MODEM, It's necessary to set this value as 2, In normal applications, this value should set to 0 or 1, the default value is 1.

◆ Databit, Parity, Stopbit

- 8N1 --- 8 Databit, No parity, 1 Stopbit
- 8E1 --- 8 Databit, Even parity, 1 Stopbit
- 8O1 --- 8 Databit, Odd parity, 1 Stopbit

AT Command:

AT+SERMODE=xxx
xxx: one of the above serial mode

◆ Communication Baudrate



Communication Baudrate: 115200

- 110 --- 110 bps
- 300 --- 300 bps
- 600 --- 600 bps
- 1200 --- 1200 bps
- 2400 --- 2400 bps
- 4800 --- 4800 bps
- 9600 --- 9600 bps
- 14400 --- 14400 bps
- 19200 --- 19200 bps
- 38400 --- 38400 bps
- 56000 --- 56000 bps
- 57600 --- 57600 bps
- 115200 --- 115200 bps

AT Command:

AT+IPR=xxx
xxx : one of the above baudrate

◆ Free time before network offline

Offline detect interval:

IP MODEM connected to the center, in a set time, no center and IP MODEM upload data, IP MODEM active disconnected with the center. When the setting time of 0, the function is invalid.

AT Command of the Free time before network offline:

AT+DTUNORECMINU=x

X is 0 to 65535 (minutes)

◆ Auto Back To Main Server

Auto Back To Main Server
(1/0 - Yes/No)

0 --- No

1 ---Yes

This item is only valid when you set “Data Center Number” as 1. In this mode, IP MODEM will switch to backup center when main center have problems. If this item is set to 1 , IP MODEM will check whether the main center work fine timely. When it detects the main server work fine, it will return back to the main server at once.

AT Command:

AT+RETMAN=x

x : 0 or 1

◆ Device ID

Device ID (8 Bytes
Hex-Decimal Characters) :

The identity number of IP MODEM, the value should be 8 bytes hex-decimal characters.

AT Command:

AT+IDNT=aabbccdd

aabbccdd: the identity number of IP MODEM

◆ SIM Card No

SIM Card No (11 Bytes)

The phone number of the SIM card .

AT Command:

AT+PHON=xxxxxxxxxx
 xxxxxxxxxxxx: the SIM card phone number

◆ Bytes Interval



The time interval used to determine whether the serial data frame transmission has completed, IP MODEM will send the serial data to the center when two bytes transmit time interval larger than this item value.

AT Command:

AT+BYTEINT=xxx
 xxx: bytes interval time value (millisecond)

◆ Custom hex heartbeat and registered package

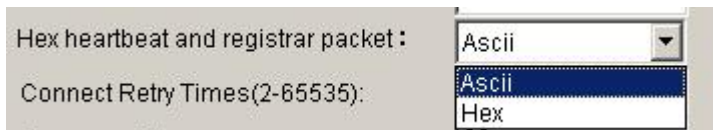

This item is only valid when the WorkMode is TCST.Used to configure a custom heartbeat packets and custom registration packet content, specific as follows:

Ascii: The string, the input and uploaded to the center of the same content.
 Hex: Hexadecimal string.for example: Enter 313233, reported value is: 123

AT Command of the Hex heartbeat package& registered package:

AT+HEXLOGIN=x
 0: Ascii;
 1: Hex;

- Note:**
1. Hexadecimal input must be an even number of characters, and in the 0-9 or a-f within the scope of the three groups.
 2. Once modify this parameter, the “Custom Register String” and “Custom Heartbeat String” need to reset.

◆ Custom Register String

Custom Register String:

This item is only valid when the WorkMode is TCST. It's the self defined register string. It can be empty, the maximum length is 70 bytes.

AT Command:

AT+CONNRGST=xxx
xxx: self defined register string

◆ Custom Heartbeat String

Custom Heartbeat String:

This item is only valid when the WorkMode is TCST. It's the self defined heartbeat string, It can be empty, the maximum length is 70 bytes.

AT Command:

AT+LINKRGST=xxx
xxx: self defined heartbeat string

Connect Retry Times, Reconnect Time Interval

Connect Retry Times:
Reconnect Time Interval (Seconds):

In normal applications, IP MODEM will always try to connect with the center even if the center has problems or closed. To reduce these unnecessary wireless data flow, you can configure the "Connect Retry Times" and "Reconnect Time Interval" items. When IP MODEM fail to connect to the center with the configured Retry Time, It will sleep "Reconnect Time Interval" time, then start next retry.

"Connect Retry Times" AT Command:

AT+RETRY=xxx
xxx: times try to connect to the center

"Reconnect Time Interval" AT Command:

AT+RDLWT=xxx

xxx: the sleep time until next retry.

◆ Transfer meaning

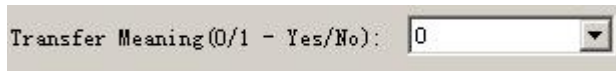

0 --- Yes, enable transfer meaning

1 --- No, disable transfer meaning

This item is only valid when the WorkMode is PROT. If this item is set to 0, IP MODEM will transfer meaning to 0xfd and 0xfe. To know detail transfer meaning method, please refer <<IP MODEM Transfer Meaning Explanation In the PROT work mode>>. If this item is set to 1, all the transmission is transparent.

AT Command:

AT+STRAIGHT=x

x: 0 or 1

◆ TTL lower heartbeat mechanism

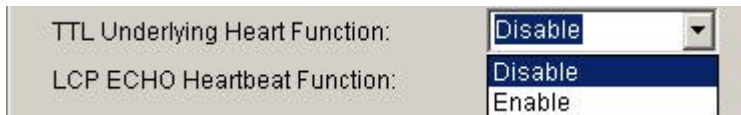

Only the IP MODEM is effective in server mode or UDP mode. If you enable this function will be judged by TTL heartbeat IP MODEM IP MODEM online status.

“TTL lower heartbeat mechanism” AT Command:

AT+EXFUN=x

When x is 0 to disable the TTL heartbeat mechanism

When x is 3 open TTL heartbeat mechanism

◆ LCP ECHO heartbeat mechanism

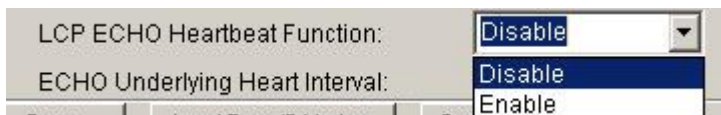

This is IP MODEM in LCP layer a heartbeat detection mechanism.

“LCP ECHO heartbeat mechanism” AT Command:

[Xiamen Four-Faith Communication Technology Co.,Ltd.](http://www.four-faith.com)

Add: J1-J3, 3rdFloor, No.44, Guanri Road, Software Park, Xiamen .361008.China

http://www.four-faith.com Tel: +86-592-6300320 Fax: +86-592-5912735

AT+ECHOENABLE=x

When x is 0 to disable the LCP ECHO heartbeat mechanism

When x is 1 open the LCP ECHO heartbeat mechanism

◆ The ECHO of the underlying heartbeat interval

ECHO Underlying Heart Interval:

This layer for IP MODEM in LCP heartbeat detection mechanism of the heartbeat interval.

“The ECHO of the underlying heartbeat interval” AT Command:

AT+ECHOINT=x

X is 1 ~ 65535

3.5.3 Other Settings

◆ Network

APN:	<input type="text" value="cmnet"/>
Username:	<input type="text" value="0"/>
Password:	<input type="text" value="0"/>
Call Center:	<input type="text" value="*99***1#"/>

APN: access point name.

Username: username to login the ISP network.

Password: password to login the ISP network

Call Center: the call center phone number

PPP Authentication Mode: the Authentication mode in PPP dial.

Model	APN	Username and password	Call center
F2114	Cmnet	null	*99***1#
F2214	null	card	#777
F2414	3gnet	null	*99#
F2614	null	card	#777

AT Command of APN:

AT+APN=xxxx

xxxx: access point name

AT Command of Username:

[Xiamen Four-Faith Communication Technology Co.,Ltd.](http://www.four-faith.com)

Add: J1-J3, 3rdFloor, No.44, Guanri Road, Software Park, Xiamen .361008.China

http://www.four-faith.com Tel: +86-592-6300320 Fax: +86-592-5912735

AT+USERNAME=xxx

xxx: username

AT Command of Password:

AT+PASSWORD=xxx

xxx: password

AT Command of Call Center:

AT+CEN=xxx

xxx: call center phone number of ISP

AT Command of PPP Authentication Mode:

AT+PAUTH=xxx

xxx: authentication mode. xxx can be "AUTO", "CHAP" or "PAP"

◆ SMS Center



Your local SMS center number

AT Command:

AT+SMSC=xxx

xxx: your local SMS center number

◆ Heartbeat Interval

Time interval sent heartbeat packet. (unit is second)

AT Command:

AT+POLLTIME=xxx

xxx: heartbeat packet time interval

◆ Call Trigger Phone No



This item is only valid when the "Trigger Type" is CTRL or MIXD. In this trigger type, IP MODEM will keep in idle state until it receives the trigger phone call, then it will connect to the center.

AT Command:

AT+CTRLNO=xxx
xxx : trigger phone number

◆ SMS Trigger Password

SMS Trigger Password(4 Bytes):

This item is valid only when the “Trigger Type” is SMSD or MIXD, IP MODEM will keeps in idle state until it receives the trigger short message, Then it will connect to the center.

AT Command:

AT+SMSDPSWD=xxx
xxx : SMS content to trigger IP MODEM online

◆ Data Trigger Password

Data Trigger On Password:
Data Trigger Off Password:

This item is valid only when the “Trigger Type” is DATA or MIXD, IP MODEM will keeps in idle state until it receives the trigger on data, then it will connect to the center, It will return to the idle state when receives trigger off data.

AT Command of Data Trigger On Password:

AT+DONPSWD=xxx
xxx : data trigger on password

AT Command of data trigger off password:

AT+DOFFPSWD=xxx
xxx :data trigger off password

◆ TCP MTU

The maximum transmission unit of TCP packet

AT Command:

AT+TCPMTU=xxx
xxx : the MTU value

Xiamen Four-Faith Communication Technology Co.,Ltd.

Add: J1-J3, 3rdFloor, No.44, Guanri Road, Software Park, Xiamen .361008.China
http://www.four-faith.com Tel: +86-592-6300320 Fax: +86-592-5912735

◆ Multi Center Reconnect Interval

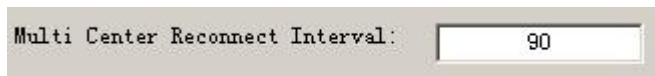

This item is valid only when the “Data Center Number” is greater than 1. When one of the configured data center lost connection, IP MODEM will try to reconnect after the configured reconnect interval

AT Command:

AT+MCONTIME=xxx

xxx : reconnect time interval (unit is second)

◆ Setting by AT command of SMS

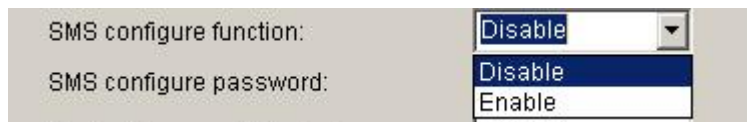

When parameters configuration using this way, the length of SMS should not more than 140 bytes, It means that does not support long SMS.

Note: When parameters configuration using this way, the contents of setting must not include a semicolon.

The following format:

<password;command1;command2...>

password: This is a valid setting command, when this password is the same as the password at “SMS Configure PassWord”.

command: one sms can include multiple commands. AT command remove AT+ remaining command. This command is AT command of SMS. Multiple commands are separated by a semicolon.

...: This symbol indicates that one sms can include multiple commands.

For example: <123456;IPAD=120.42.46.98;PORT=5007>

description: password is 123456, main center IP is 120.42.46.98, main center port is 5007.

SMS setting response as following:

setting successful: DTU will send one response SMS to user. SMS content: command(Corresponding setting command): Configure successful.

setting failed: DTU will send one response SMS to user, SMS content: command(Corresponding setting command): Configure failed.

Xiamen Four-Faith Communication Technology Co.,Ltd.

Add: J1-J3, 3rdFloor, No.44, Guanri Road, Software Park, Xiamen .361008.China
http://www.four-faith.com Tel: +86-592-6300320 Fax: +86-592-5912735

AT Command:

AT+SMSCF=x

When the x configuration parameter to 0 to disable the messages

When the x configuration parameter to 1 to enable messages

◆ SMS Configure PassWord

SMS configure password:

This is the configuration parameter password configuration text messages.

AT Command:

AT+SMSCPW=xxx

xxx : To set the password, the maximum length of 6

3.5.4 ModBus Setting

◆ ModBus work mode

ModBus work mode:

ModBus address<1-247>:

“ModBus Work mode” used for configuring the RTU work mode. There are the following options:

Disable MOBUS: disable MODBUS function

Network RTU: RTU uses TCP to virtual serial port convert software to support MODBUS RTU protocol(the data transmitted over ip network).

Serial Port RTU: RTU uses RS232/RS485 to support MODBUS RTU protocol.

Command: AT+MBMODE=x

Explanation: set MODBUS functions work mode.

Parameter: x range 0-2, 0 means Disable MOBUS, 1 means Network RTU, 2 means Serial Port RTU.

Example: AT+MBMODE=0

◆ ModBus address

ModBus address<1-247>:

It sets MODBUS device address of this RTU, server identify devices based on this address.

Command: AT+MBADDRESS=x
 Explanation: set MODBUS device address.
 Parameter: x range 1-247.
 Example: AT+MBADDRESS=1

3.5.5 Port Interface Settings

◆ Analog working mode

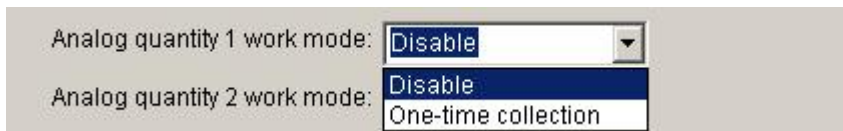

Analog working mode:

Don't enable: analog acquisition function to shut down

Open the one-time acquisition: analog acquisition function

command: AT+ADCMODEn=x

instructions : N: on behalf of the analog channel, the value 1 or 2;X: 0 means is not enabled, 1 for one-time acquisition

Example: set the analog 1 working mode to one-time acquisition

AT+ADCMODE1=1

◆ Digital volume work mode

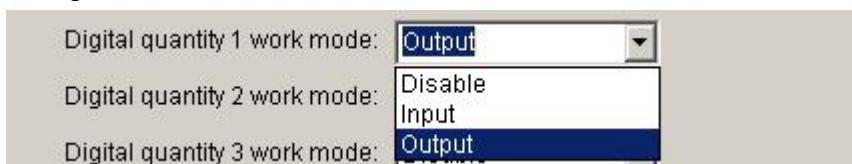

Data volume work mode:

Is not enabled, the data quantity function to shut down

Work entered: amount of data in input mode

Work output: the amount of data in the output mode

command: AT+DIOWORKMODEn=x

instructions : N: on behalf of the amount of data channel, values 1, 2, or 3;X: 0 is not enabled, 1 input, 2 output

Example: Set the data volume 1 work mode to output

AT+DIOWORKMODE1=2

3.5.6 SMS Setting

◆ Set the SMS backup

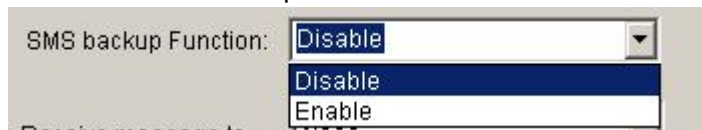

IP MODEM : After the equipment connected to the network interruption, serial data received will be issued by text messages.

Ban: to disable this feature

Open: open this function

AT Command:

AT+OPENSMSBCKP=x

X is 0 to 1, 0 disables, 1 is open.

◆ SMS Sending Format



Common SMS: It means visible characters. ASCII code value is less than 127.

HEX SMS: It can send any hexadecimal number of 0x00-0xff.

AT Command:

AT+HEXSMS=x

x range 0-1 0 means common SMS, 1 means HEX SMS.

◆ SMS receive to the serial port



IP MODEM: After receiving the message to the “phone number, SMS content “format to the serial port output.

open: open this function

close: disable this function

AT Command:

AT+SMSDIS=x

x range 0-1,0 disables, 1 is open.

◆ Destination sms number

[Xiamen Four-Faith Communication Technology Co.,Ltd.](http://www.four-faith.com)

Add: J1-J3, 3rdFloor, No.44, Guanri Road, Software Park, Xiamen .361008.China

http://www.four-faith.com Tel: +86-592-6300320 Fax: +86-592-5912735

SMS Sending Number Setting(5 Number per group,divided by',')

SMS Sending

SMS Sending

SMS Sending

SMS Sending

These parameters should be set only when the “SMS backup” function is enable, The DTU will send report information by SMS. This parameter used for setting SMS destination number. Five phone numbers can be configured at each group, Each phone numbers are separated by comma. The length of each phone number should less than 15 bytes.

AT Command:
 AT+PHONEn=xxx
 n range 1-4 correspond to group 1-4.
 xxx means destination phone number.

3.6 Functions

◆ Clear Output

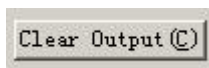

Clear the output information

◆ Version Display

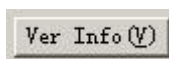

Show the software and hardware version

◆ Signal Value

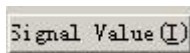

Display current wireless signal value

◆ Factory setting



Restore to factory settings

◆ Show Config



Show current IP MODEM settings

◆ Show Baudrate



Display the communication baudrate

◆ Auto Detect



Simple way to determine whether IP MODEM work fine

◆ Save Output



Save the output info to a file

◆ Save Config



Save the current settings to a file, you can restore it from this file later

◆ Restore Config



Restore settings from a previous saved configure file

◆ RTC time settings



Set the RTC clock of the device. click on the 'RTC' will jump out of the configuration interface as shown below, which has two settings options:

System time: directly set the current time of the PC machine;

Manual setup: manual configuration time;

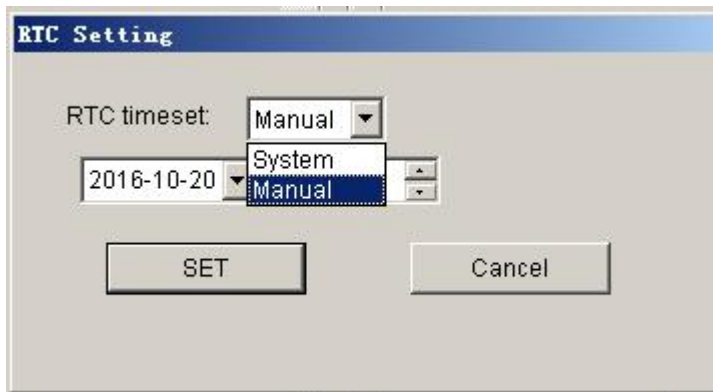

◆ Language setting



Use language to set up.

3.7 Work State Switch

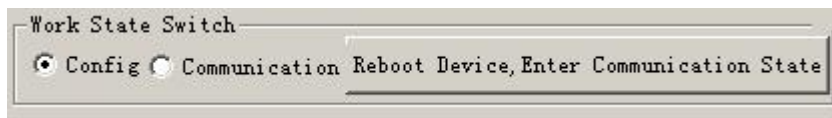

This tool can work in two states, “Config” and “Communication”

Config:

This state is used to configure parameters of IP MODEM.

Communication:

This state is used as a common serial communication tool

Reboot Device, Enter Communication State:

This function button is used to reboot IP MODEM and make the software switch to Communication state

Appendix

The following steps describe how to make IP MODEM enter configure state with the Windows XP Hyper Terminal.

1. Press “Start”→”Programs”→”Accessories”→”Communications”→”Hyper Terminal”



2. Input connection name, choose “OK”
3. Choose the correct COM port which connect to IP MODEM, choose “OK”



4. Configure the serial port parameters as following, choose “OK”

Bits per second: 115200

Data bits: 8
Parity: None
Stop bits: 1
Flow control: None

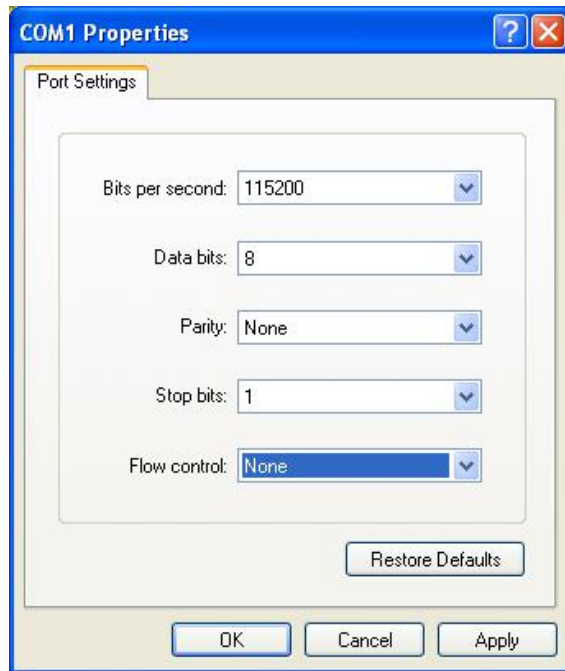

5. Complete Hyper Terminal operation, It runs as following

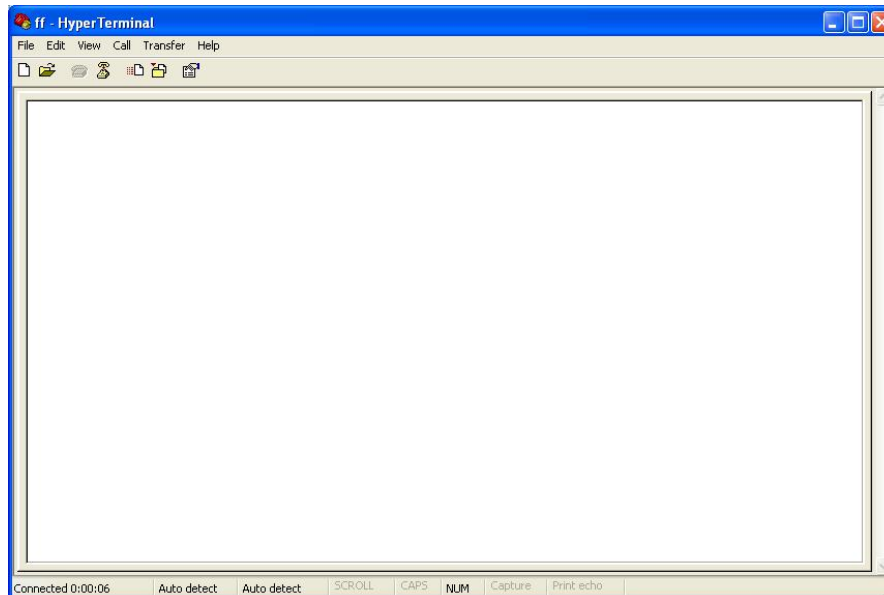

6. Re-power IP MODEM, put mouse focus on the Hyper Terminal and press “s” key continuously until IP MODEM enter configure state as following

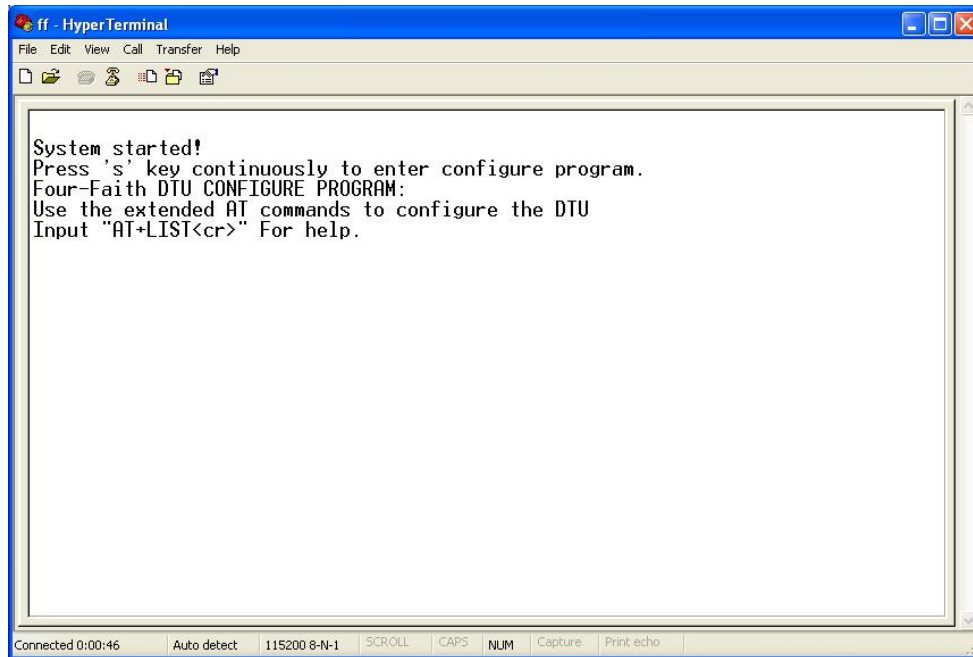

7. IP MODEM has entered configure state, you can configure the parameters through AT command.