

F2910 Series NB-IoT Terminal User Manual	Document Version	Page
	V1.0.0	
	Product Name: F2910	Total:25

F2910 Series NB-IoT Terminal User Manual

The user manual is suitable for the following model:

Model	Product Type
F2910-B5	B5 NB-IoT Terminal
F2910-B8	B8 NB-IoT Terminal
F2910-B20	B20 NB-IoT Terminal



[Xiamen Four-Faith Communication Technology Co., Ltd.](#)

Add: 11th Floor, A-06 Area, No.370, Chengyi Street, Jimei,
Xiamen, Fujian, China.

Tel: +86 592-5907276 Fax:+86 592-5912735

Web:en.four-faith.com





Files Revised Record

Date	Version	Remark	Author
2017-12-01	V1.0.0	Initial version	WSP

Copyright Notice

All contents in the files are protected by copyright law, and all copyrights are reserved by Xiamen Four-Faith Communication Technology Co., Ltd. Without written permission, all commercial use of the files from Four-Faith are forbidden, such as copy, distribute, reproduce the files, etc., but non-commercial purpose, downloaded or printed by individual (all files shall be not revised, and the copyright and other proprietorship notice shall be reserved) are welcome.

Trademark Notice

Four-Faith、四信、、、、 are all registered trademarks of Xiamen Four-Faith Communication Technology Co., Ltd., illegal use of the name of Four-Faith, trademarks and other marks of Four-Faith is forbidden, unless written permission is authorized in advance.



Note: There may be different components and interfaces in different model, please in kind prevail.

Contents

Chapter 1	Brief Introduction of Product.....	6
1.1	General.....	6
1.2	Features and Benefits.....	6
1.3	Working Principle.....	7
1.4	Specifications.....	8
Chapter 2	Installation Introduction.....	10
2.1	General.....	10
2.2	Encasement List.....	10
2.3	Installation and Cable Connection.....	10
2.4	Power.....	13
2.5	Indicator Lights Introduction.....	13
Chapter 3	Configuration.....	14
3.1	Configuration Connection.....	14
3.2	Configuration Introduction.....	14
3.3	Run the configure Tool.....	14
3.4	Re-power NB-IoT Terminal.....	16
3.5	Configuration.....	16
3.5.1	Data Service Center Settings.....	16
3.5.2	NB-IoT Terminal Settings.....	17
3.5.3	Interface Settings.....	21
3.6	Functions.....	23
Appendix	24

Chapter 1 Brief Introduction of Product

1.1 General

F2910 series NB-IoT Terminal is a kind of Internet of things device that provides data transfer by public NB-IoT network.

It adopts high-powered industrial 32 bits CPU and embedded real time operating system. It supports RS232 and RS485 port that can conveniently and transparently connect one device to a NB-IoT network, allowing you to connect to your existing serial devices with only basic configuration. It has low power consumption states. It has compatible 5 digital I/O channels, ADC, input pulse counter and pulse wave output function.

It has been widely used on M2M fields, such as wireless meter reading, smart city, smart grid, intelligent transportation, fire protection, asset tracking, mobile terminal POS, logistics, industrial automation, digital medical, military, agriculture, forestry, water, coal, petrochemical and other fields of data transmission.



1.2 Features and Benefits

Design for Industrial Application

- ◆ High-powered industrial NB-IoT module
- ◆ High-powered industrial 32 bits CPU
- ◆ Low power consumption design, support multi-sleep and trigger modes to reduce the power dissipation farthest
- ◆ Embedded Real Time Clock(RTC) circuit

- ◆ Housing: iron, providing IP30 protection
- ◆ Power range: DC 5~36V

Stability and Reliability

- ◆ Support hardware and software WDT
- ◆ Support auto recovery mechanism, including online detect, auto redial when offline to make it always online
- ◆ RS232/RS485 ports:15KV ESD protection
- ◆ SIM/UIM port: 15KV ESD protection
- ◆ Power port: reverse-voltage and overvoltage protection
- ◆ Antenna port: lightning protection(optional)

Standard and Convenience

- ◆ Adopt terminal block interface, convenient for industrial application
- ◆ Support standard RS232/RS485 ports that can connect to serial devices directly
- ◆ TTL logic level RS232 interface can be customized
- ◆ Support intellectual mode, enter into communication state automatically when powered
- ◆ Provide management software for remote management
- ◆ Support several work modes
- ◆ Convenient configuration and maintenance interface

High-performance

- ◆ Supply 5 I/O channels, compatible 5pulse wave output channels, 5 analog inputs and one pulse input counters
- ◆ Support multi data centers and it can support 5 data centers at the same time
- ◆ Support dynamic domain name(DDNS) and IP access to data center
- ◆ Design with standard UDP/COAP protocol stack,Support transparent data transmission

1.3 Working Principle

The principle block diagram of the NB-IoT terminal is as follows:

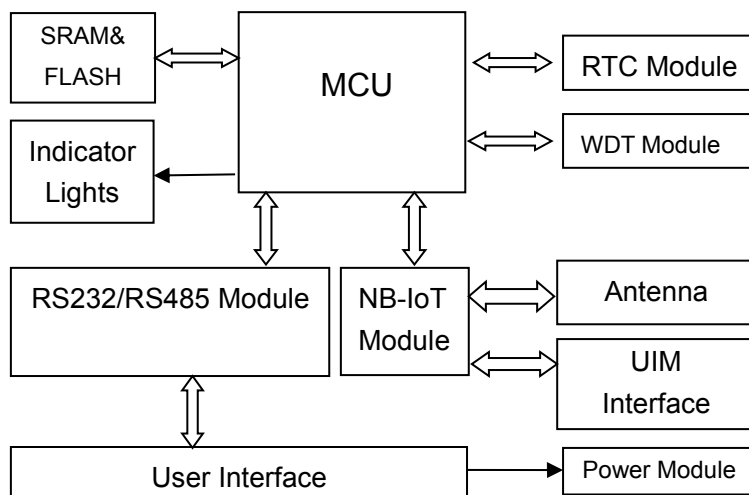

1.4 Specifications

NB-IoT Specification

ITEM	CONTENT
F2910 NB-IoT Terminal	
Standard and Band	B5: 850MHz B8: 900MHz B20: 800MHz
Bandwidth	100bps~100Kbps
TX power	23±1dBm
RX sensitivity	<-129dBm

Hardware System

Item	Content
CPU	Industrial 32 bits CPU
FLASH	512KB(Extendable)
SRAM	256KB(Extendable)

Interface Type

Item	Content
Serial	1 RS232 port and 1 RS485 port, 15KV ESD protection Data bits: 5, 6, 7, 8 Stop bits: 1, 1.5, 2 Parity: none, even, odd, space, mark Baud rate: 110~230400 bps
Indicator	"Power", "ACT", "Online"
Antenna	Standard SMA female interface, 50 ohm, lightning protection(optional)
SIM/UIM	Standard user card interface, support 1.8V/3V SIM/UIM card,

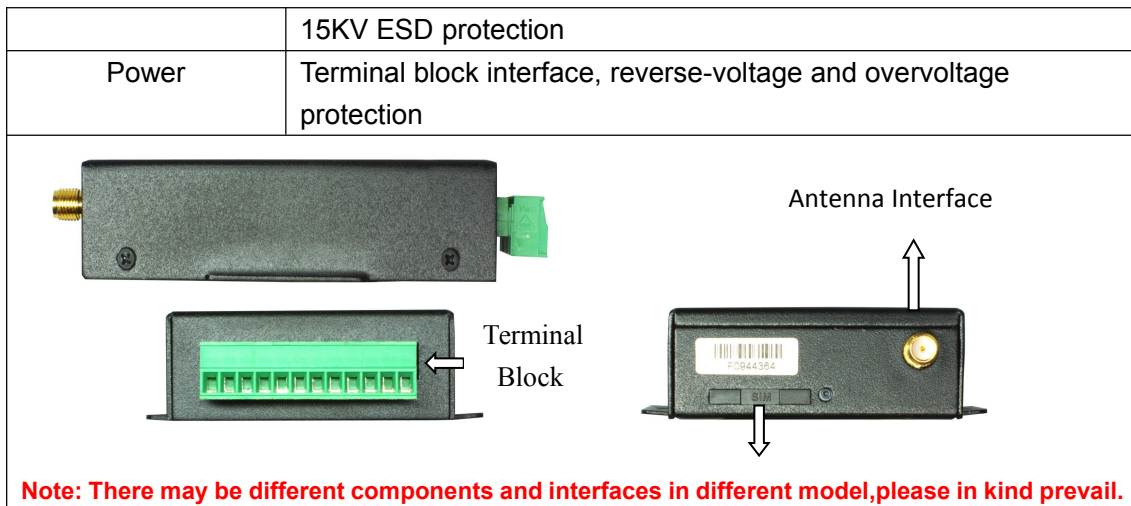

Power Input

Item	Content
Standard Power	DC 12V/0.5A
Power Range	DC 5~36V

Consumption

Working condition	Consumption
Deep Sleep	35-40uA@12VDC
Common Sleep	1-2mA @12VDC
Standby	5~7mA@12VDC
Communication	15~20mA@12VDC

Physical Characteristics

Item	Content
Housing	Iron, providing IP30 protection
Dimensions	91x58.5x22 mm
Weight	210g

Environmental Limits

Item	Content
Operating Temperature	-35~+75°C(-31~+167°F)
Storage Temperature	-40~+85°C(-40~+185°F)
Operating Humidity	95% (Non-condensing)

Chapter 2 Installation Introduction

2.1 General

The NB-IoT Terminal must be installed correctly to make it work properly.

Warning: Forbid to install the NB-IoT Terminal when powered!

2.2 Encasement List

Name	Quantity	Remark
NB-IoT host	1	
Antenna	1	
Power adapter	1	
RS232 data cable	1	optional
RS485 data cable	1	optional
Manual CD	1	
Certification card	1	
Maintenance card	1	

2.3 Installation and Cable Connection

Dimension: (unit: mm)

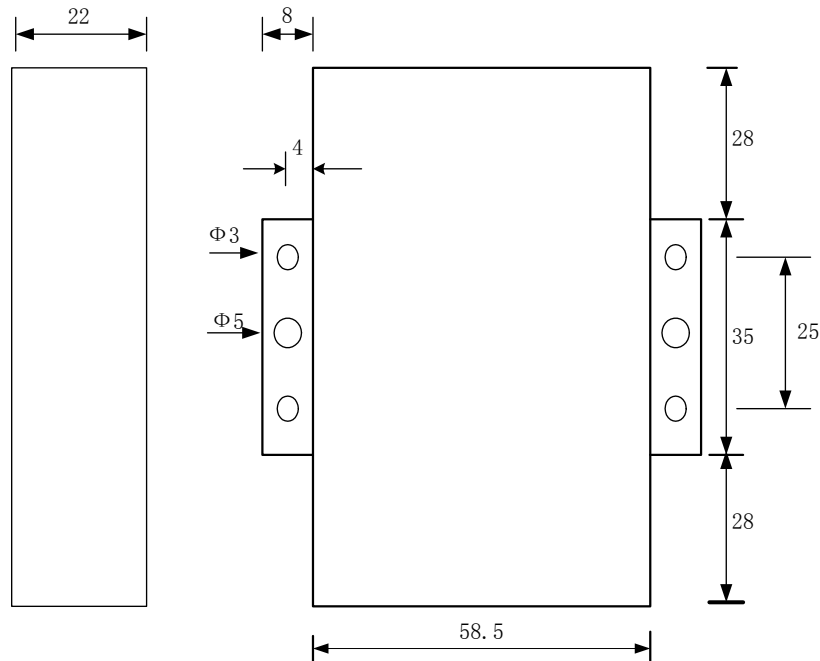

Installation of SIM/UIM card:

Firstly power off the NB-IoT Terminal, and press the out button of the SIM/UIM card outlet with a needle object. Then the SIM/UIM card sheath will flick out at once. Put SIM/UIM card into the card sheath (Pay attention to put the side which has metal point outside), and insert card sheath back to the SIM/UIM card outlet.

Warning: Forbid to install SIM/UIM card when powered!

Installation of antenna:

Screw the SMA male pin of the antenna to the female SMA outlet of the NB-IoT Terminal tightly. Warning: The antenna must be screwed tightly, or the signal quality of antenna will be influenced!

User Interface Signal Definition

Pin Number	Signal Name	Default Function	Extensible Function
1	PWR	Power input anode	N/A
2	GND	Power Ground	N/A
3	GND	Power Ground	N/A
4	RX	RS232 RX	Reserved compatibility TTL RX
5	TX	RS232 TX	Reserved compatibility TTL TX
6	A	RS485 anode	Reserved compatible TTL RX
7	B	RS485 cathode	Reserved compatible TTL TX
8	IO1	GPIO	Can customize the function of pulse output, pulse count and analog input.
9	IO2	GPIO	Can customize the function of pulse

			output, pulse count and analog input.
10	IO3	GPIO	can customize the function of pulse output, pulse count and analog input.
11	IO4	ADC, analog input function (current collection 0 ~ 20 mA)	can customize the function of pulse output, pulse count and analog input.
12	IO5	ADC, analog input function (current collection 0 ~ 20 mA)	can customize the function of pulse output, pulse count and analog input.



Installation of cable:

F2910 adopts industrial terminal block interface. The recommendatory cable is 28-16AWG. The detail description of standard layout adapter and communication cables as is following:

Adapter (Rating Output 12VDC/0.5A) :

Cable Color	Power Output Polarity
Black & White Alternate	Anode
Black	Cathode

RS232 Cable:

Cable Color	Corresponding DB9-M Pin Number
Brown	Pin 2
Blue	Pin 3
Black	Pin 5

RS485 Cable:

Cable Color	Signal definition
Red	RS485(A)
Black	RS485(B)

Power adapter and communication cable connection chart as following:

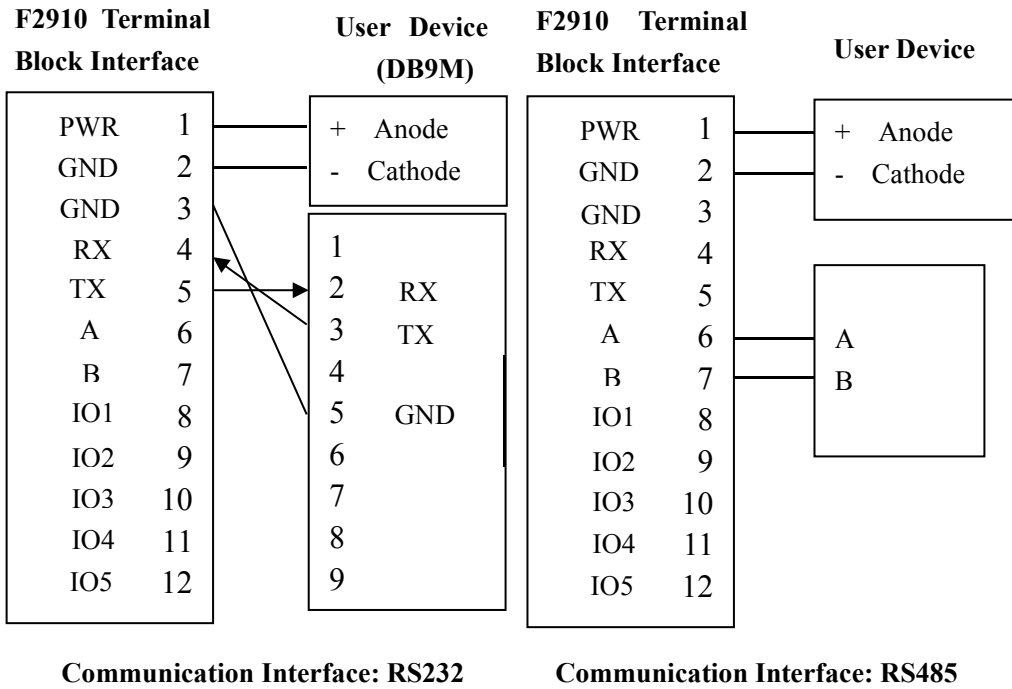

2.4 Power

The power range of the NB-IoT is DC 5~36V.

Warning: When we use other power, we should make sure that the power can supply power above 4W.

We recommend user to use the standard DC 12V/0.5A power.

2.5 Indicator Lights Introduction

The NB-IoT Terminal provides three indicator lights: “Power”, “ACT”, “Online”.

Indicator Light	State	Introduction
Power	ON	NB-IoT Terminal is powered on
	OFF	NB-IoT Terminal is powered off
ACT	BLINK	Data is communicating
	OFF	No data
Online	ON	NB-IoT Terminal has logged on network
	OFF	NB-IoT Terminal hasn't logged on network

Chapter 3 Configuration

3.1 Configuration Connection

Before configuration, it's necessary to connect the NB-IoT Terminal with the configure PC by the shipped RS232 or RS232-485 conversion cable as following.

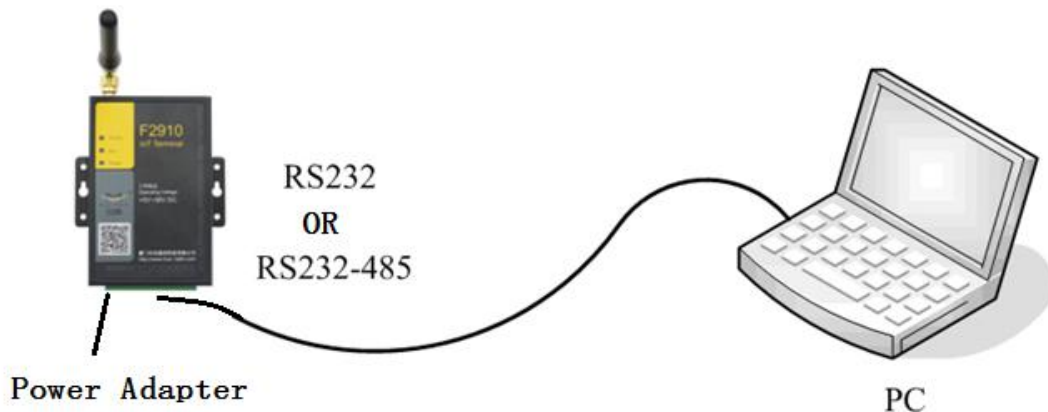

3.2 Configuration Introduction

There are two ways to configure the NB-IoT:

Configuration software tool: All the settings are configured through the shipped software tool. It's necessary to have one PC to run this tool.

Extended AT command: All the settings are configured through AT command, so any device with serial port can configure it. Before configuration with extended AT command, you should make NB-IoT enter configure state. Please refer to appendix about the steps how to make NB-IoT enter configure state .

Here introduce how to configure NB-IoT using configure software tool and corresponding AT command of each configuration item.

3.3 Run the configure Tool

NB-IoT Terminal F2910_V1.0.3.exe

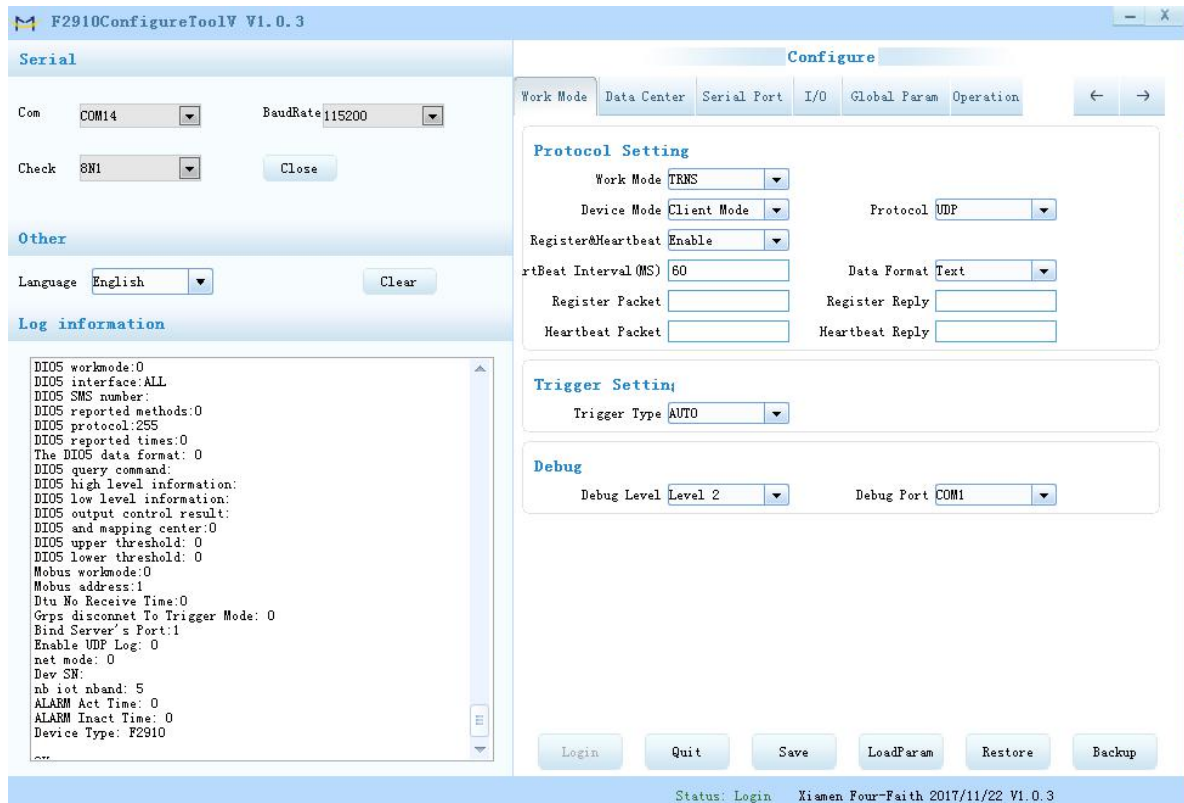

The “Serial Parameters” column shows the current serial port settings. To configure NB-IoT, please choose the correct serial port which is connected to NB-IoT, and the baud-rate is 115200 with no parity, then open the serial port. The serial port has been opened if the button text is “Close”. If the text is “Open”, you should open the port first. When the port opened, the “Output Info” column will display

“Port(COM1) Has Opened, Please Re-Power the NB-IoT,
Waiting NB-IoT Enter Configure State...”

3.4 Re-power NB-IoT Terminal

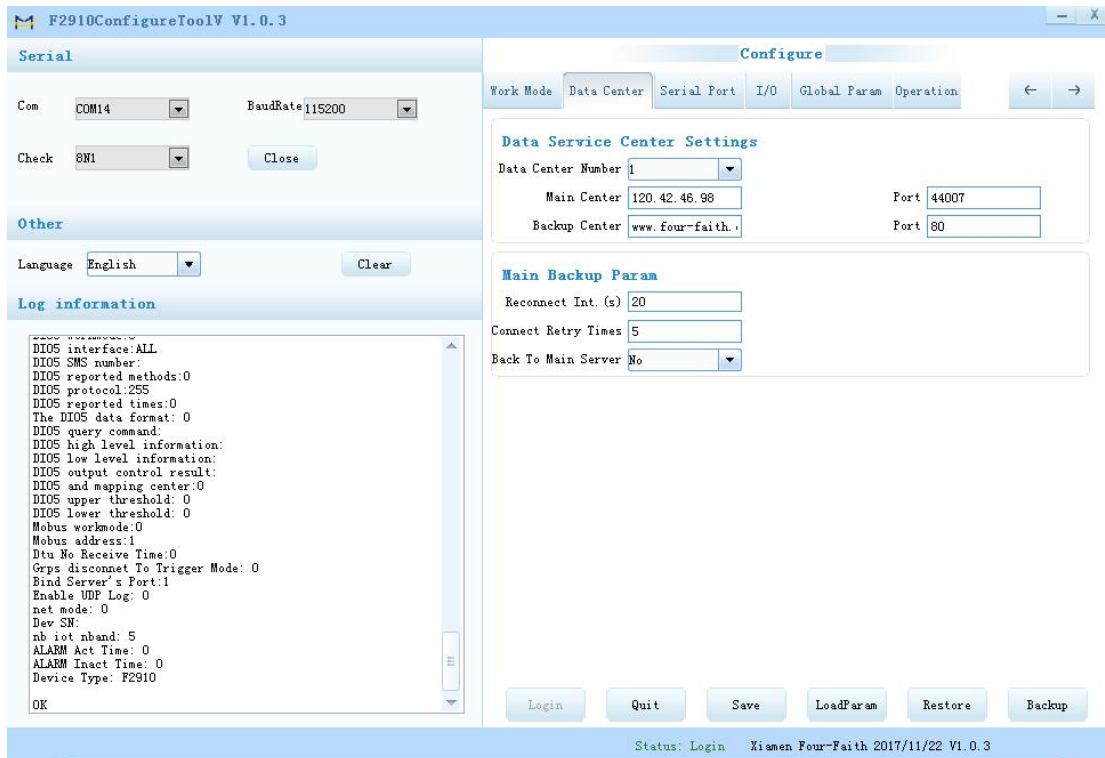

After Re-power NB-IoT Terminal, The configure tool will make it enter configure state. At the same time, the software will load current settings from NB-IoT Terminal and displays on the right configure columns at the same time.. It's now ready to configure.

3.5 Configuration

3.5.1 Data Service Center Settings

There are the configurations of the data service center in the center server parameter page.

◆ Number of central servers

The NB-IoT terminal supports two ways of data center to receive data:

One is main and backup way. When the NB-IoT terminal is online, it will connect to main center first. If the connection is successful, NB-IoT terminal will communicate with main center, otherwise NB-IoT terminal will try to connect the backup center for data communication.

Note: please configure secondary center and main center to be the same value if there is no secondary center.

The other is multiple centers way. NB-IoT terminals can support data communication between 5 centers at the same time. NB-IoT terminals will try to connect to multiple data

centers when they are online using this mode.

Data Service Center Settings

Data Center Number

NB-IoT terminal will work in main and backup way when data center number is 1, and main and backup center configuration will be working.

NB-IoT terminal will work in a multiple center way when data center number is bigger than 1, so backup center will be invalid, and main center and center 1~4 will be valid.

◆ Main center address, port

The IP address or domain name of the main center server, and the port proposal is set above 1024.

◆ Multi center server configuration

Data Service Center Settings

Data Center Number

1st Center	<input type="text" value="120.42.46.98"/>	Port	<input type="text" value="44007"/>
2nd Center	<input type="text" value="166.111.8.238"/>	Port	<input type="text" value="23"/>
3rd Center	<input type="text" value="166.111.8.238"/>	Port	<input type="text" value="23"/>
4th Center	<input type="text" value="166.111.8.238"/>	Port	<input type="text" value="23"/>
5th Center	<input type="text" value="166.111.8.238"/>	Port	<input type="text" value="23"/>

Multi center connection Param

Reconnect Int. (s)

Connect Retry Times

The multi center configurations will be working when the server number is bigger than 1. For example, main center will be 1st center and the number of servers is 5 when data center is 5, and center number 5 corresponds to 5 data service centers for communication.

3.5.2 NB-IoT Terminal Settings

◆ Work Mode

Protocol Setting

Work Mode

TRNS mode: In TRNS mode, the data communication is transparent transmission.

◆ Device Mode

Device Mode

- Client Mode
- Server Mode

Client Mode

In this mode, F2910 will be a TCP client, go to connect server after get online.

Server Mode

In this mode, F2910 will be a TCP server, listening on a TCP port(configurable) for clients to connect after get online

◆ Protocol

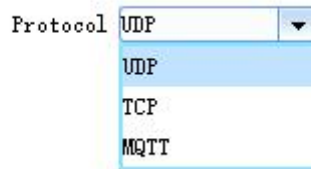

UDP

Data package from serial port will send to server in UDP protocol

TCP

Data package from serial port will send to server in TCP protocol

MQTT

Data package from serial port will send to server in MQTT protocol, you will have to configure the MQTT USER/MQTT PASS/SUB TOPIC/PUB TOPIC when you use this protocol

MQTT USER:	<input type="text"/>	MQTT PASS:	<input type="text"/>
SUB TOPIC:	<input type="text"/>	PUB TOPIC:	<input type="text"/>

◆ Trigger Type



Normally NB-IoT terminal will be online all the time, to keep the data transmission and transfer application data timely. But in some occasion where is particularly sensitive to wireless communication data flow, can make NB-IoT terminal under the standby state in order to save traffic. When activated by inside trigger way once need to transfer application data, NB-IoT terminal will be triggered to be online and establish the data transmission channel, it will hang up the connection to return to the standby state after transmission. NB-IoT terminal support following activation ways.

Automatic

This way makes the NB-IoT terminal online forever.

Serial port

Serial port activation. NB-IoT terminal will establish the connection or disconnect the communication link by sending specific data to the serial port of the NB-IoT terminal.

DIO

DIO activation. NB-IoT will be triggered to establish the connection when set Its IO port high level, and NB-IoT termnal will disconnect the connection and fall into sleep mode when set its IO port low level.

Timing

Timing activation. NB-IoT will be triggered or fall into sleep by setting a specific time.

◆ Debug Level



Debug information is used to debug software when there is software problem.

- 0 --- no debug information output
- 1 --- simple prompt information output
- 2 --- detail debug information output

Note: it is necessary to set the debugging level to 2 only when the device can't work normally and need to debug the software, debug level 2 will affect the normal data communication.

◆ Data bit, Parity, Stop bit

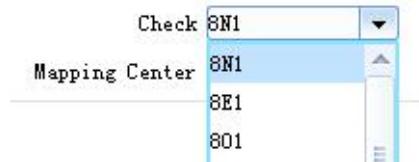

- 8N1 --- 8 Data bit, No parity, 1 Stop bit
- 8E1 --- 8 Data bit, Even parity, 1 Stop bit
- 8O1 --- 8 Data bit, Odd parity, 1 Stop bit

◆ Communication Baud rate

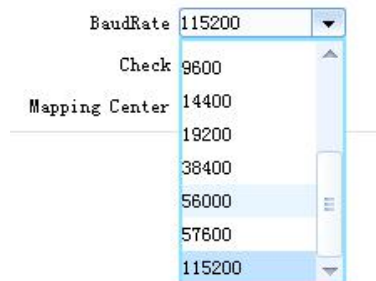

- 110 --- 110 bps
- 300 --- 300 bps
- 600 --- 600 bps
- 1200 --- 1200 bps

2400	---	2400 bps
4800	---	4800 bps
9600	---	9600 bps
14400	---	14400 bps
19200	---	19200 bps
38400	---	38400 bps
56000	---	56000 bps
57600	---	57600 bps
115200	---	115200 bps

◆ Automatically return to the main center

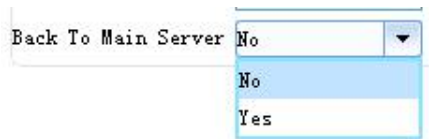

No - do not automatically return to the main center

Yes - automatically return to the main center

This configuration only works when NB-IoT terminal in the main backup mode. NB-IoT terminal will connect to backup center automatically if the main center abnormal. NB-IoT terminal will regularly test the main center is working properly if you set this to 1. It will automatically switch back to main center disconnected from the backup center if main center is normal. NB-IoT terminal will not detect the main center whether to resume normal work if this is set to 0.

◆ Data frame interval time



It is used to determine whether the serial data frame is completed. If the time interval between two bytes is longer than the set value, the NB-IoT terminal will send the current received data to the data center immediately.

◆ Sixteen-band cardiac packs registration package



This configuration only works when the NB-IoT terminal is working in the TCST protocol mode and it is used to configure the content of a custom heartbeat package and a custom registration package.

TEXT: In the form of a string, the content of the input is the same as the content that is uploaded to the center.

HEX: 16 binary string. For example, input: 313233, the reported value is: 123

- note:**
1. The character input in the 16 band must be an even number and within the three sets of 0-9 or a-f or A-F.
 2. When this parameter is modified, the custom heartbeat package and the custom registration package should be reconfigured once.

◆ Custom registration package

Register Packet

This configuration only takes effect when on the NB-IoT terminal working in the TCST protocol mode, and is used to configure a custom registration package. Can also be empty (Indicating that no registration package is sent) . The maximum length of the registered package is 70 bytes.

◆ Custom heartbeat package

Heartbeat Packet

This configuration only takes effect on the NB-IoT terminal working in the TCST protocol mode, and is used to configure a custom heartbeat package. Can also be empty (Indicating that no heartbeat package is sent) . The maximum length of the heartbeat package is 70 bytes.

◆ Reconnection setting

Main Backup Param

Reconnect Int. (s)

Connect Retry Times

In practical applications, if the central server is abnormal or close to the server, the NB-IoT terminal is always unable to establish a connection. The NB-IOT terminal will try to build connections constantly to ensure that it is always online, so that unnecessary traffic is generated. Those two configurations can prevent unnecessary waste of traffic. After the NB-IoT terminal tries to connect the number of settings, if the connection is still not established, the NB-IoT terminal will enter a dormant state. Dormant time is Set the interval between reconnected tasks. After dormant time,NB-IoT terminal will try to build a connection again.

3.5.3 Interface Settings

- ◆ Input acquisition: IO work in input mode,and IO1-IO3 is supported by default; Custom protocol:
 - i 、 Query method:When the serial port is inputting the string set by the "query

instruction";

IO for high power, serial output "high level" set of strings;

IO for low power, serial output "low level" set of strings;

I01	I/O1	Input	Protocol	Custom
	Port	ALL		
	Report Type	Query	Command	Get01Val
	Data Format	Text		
	High Level	I01_HIGHT	Low Level	I01_LOW

- ii、 Timing report: in the setting of the report interval time, the serial port output current IO status indication;

I01	I/O1	Input	Protocol	Custom
	Port	ALL		
	Report Type	Time	Interval	5
	Data Format	Text		
	High Level	I01_HIGHT	Low Level	I01_LOW

- iii、 Level change: when the IO level has a change, the serial port output current IO status indication;

I01	I/O1	Input	Protocol	Custom
	Port	ALL		
	Report Type	IO Trigger		
	Data Format	Text		
	High Level	I01_HIGHT	Low Level	I01_LOW

AT command:

Setting up the IO mode :AT+DIOWORKMODEx=1 (x corresponding IO port value: 1-5)

Read the IO state: AT+DIOVALx?

Return: +DIOVALx: 0/1

- ◆ Output control: IO works in output mode, and IO1-IO3 is supported by default;

I02	I/O2	Output	Protocol	Custom
	Port	COM1		
	Data Format	Text	Response	OK
	High Level	I02_HIGHT	Low Level	I02_LOW

Custom protocol:

- i、 When the serial port is inputting the "high level" set of strings, the IO output is high, The serial port sends back the string of "control response" set.

- ii、 When the serial port is inputting the "low level" set of strings, the IO output is low,
The serial port sends back the string of "control response" set.

AT command:

Setting up the IO mode: AT+DIOWORKMODEx=2

High level output: AT+DIOSETx

Low level output: AT+DIOCLR x

- ◆ Device status indication: IO is used to indicate the state of the device, and the default support for IO1-IO3;

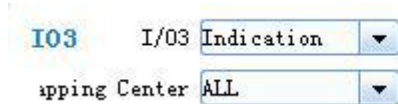

AT command:

Setting up the IO mode: AT+DIOWORKMODEx=3

Setting the data center :AT+DIOMAPCx=n (n the data center:1-5)

High level:Online

Low level:Offline

- ◆ Sleep wake-up activation: IO is used for sleep wake-up activation control, and IO1-IO3 is supported by default;



AT command:

Setting up the IO mode:AT+DIOWORKMODEx=4

When the activation mode is set to IO activation,

High level:activation

Low level:sleep

- ◆ADC collection: IO works in analog quantity acquisition mode, and IO4-IO5 is supported by default.



AT command:

Setting up the IO mode: AT+DIOWORKMODEx=6

Read the ADC value :AT+DIOVALx?

Return:+DIOVALx: ADC_VAL

Current acquisition formula: $I = (ADC_VAL * 3.3) / (4095 * 150); //(\text{Unit:A})$

Voltage acquisition formula: $V = (ADC_VAL * 3.3) / (4095 * 0.6); //(\text{Unit:V})$

3.6 Functions

- ◆ Language setting

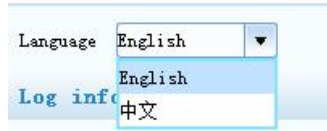

Used to set up the use language

- ◆ clear window



used to clear window output Information

- ◆ Detection version

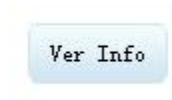

used to detect Software and hardware versions

- ◆ signal intensity



used to detect the signal intensity of the current network

- ◆ Factory configuration



recovery NB-IoT terminal to Factory configuration

- ◆ RTC Timing

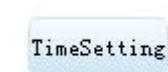

Set the PC current time for NB-IoT terminal

Appendix

The following steps describe how to make NB-IoT Terminal enter configure state with the Windows XP Hyper Terminal.

1. Press "Start"→"Programs"→"Accessories"→"Communications"→"Hyper Terminal"



2. Input connection name, choose “OK”
3. Choose the correct COM port which connect to NB-IoT Terminal , choose “OK”



4. Configure the serial port parameters as following, choose “OK”
 - Bits per second: 115200
 - Data bits: 8
 - Parity: None
 - Stop bits: 1
 - Flow control: None

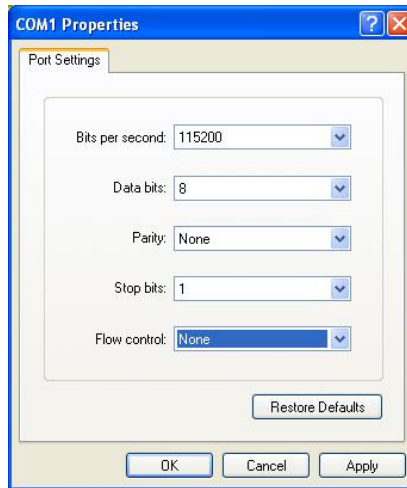

5. Complete Hyper Terminal operation, It runs as following.

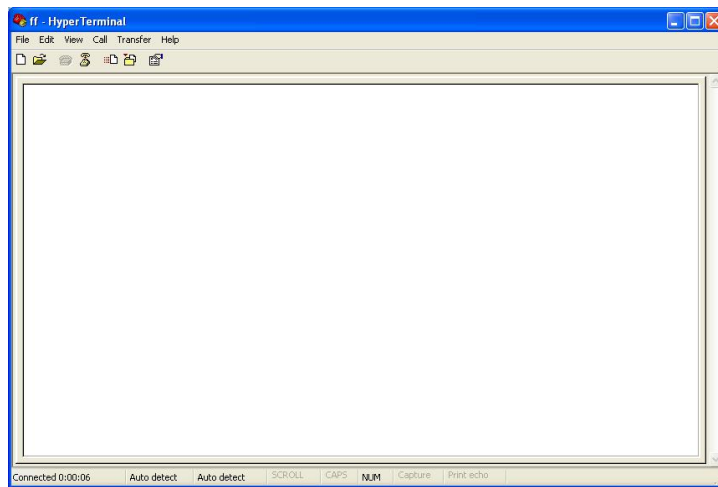

6. Re-power NB-IoT Terminal, put mouse focus on the Hyper Terminal and press “s” key continuously until NB-IoT Terminal enter configure state as following.

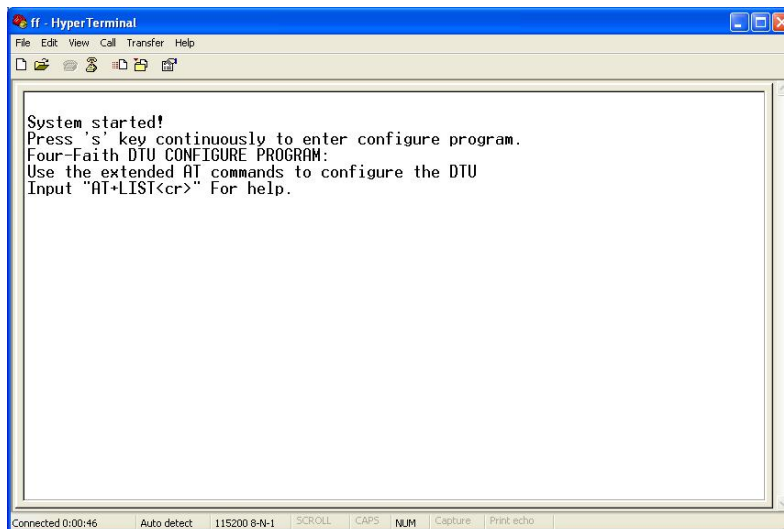

7. NB-IoT Terminal has entered configure state, you can configure the parameters through AT command.